

Cabinets



Cabinets

ClicBox

ClicBox By BA is an unique concept in kitchen cabinets. Using the patented UNICLIC for furniture technology, means the different components just clic together. This is set to revolutionise cabinet assembly.



The UNICLIC technology

The UNICLIC technology is a tongue and groove solution which enables a click connection at an angle of 90°. This revolutionary technology makes it possible to assemble flat packed kitchen cabinets by simply clicking the components together, without requiring any tools or screws!



Stronger Connection

The click connection is stronger than a traditional assembly system as the joints interlock along the entire assembly length instead of only on 2 fixing points.



No Visible Fittings

As there are no fittings required with UNICLIC, the technology is completely invisible.



Cert No. PC0051

The ClicBox Kitchen Range has been tested at FIRA International Ltd and successfully meets the structural performance requirements for FIRA Gold certification to Heavy Domestic / Contract Kitchen Furniture: FPG S006 – Level H Specification.

Easy as
1 - 2 - 3

0:00



0:06

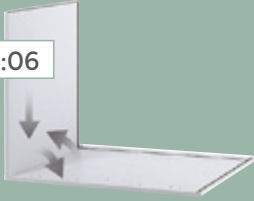

0:15



0:24



0:30



- Assemble on site
- No tools, no missing fittings
- Less chance of damage in transit
- 67% saving in vehicle space
- Suitable for limited access areas
- Ideal for multiple floor buildings
- Less time, more profit
- Standard size cabinets despatched in 24 hours.

Product features that make the difference

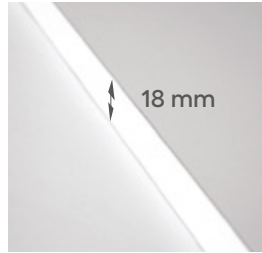

18mm thick MFC panels, 1mm ABS on leading edges



8mm solid MDF back



No fittings because of UNICLIC technology



Solid top and bottom are interchangeable



18mm adjustable shelves; 3 possible heights



Tool-less adjustable legs. Height - 150mm



Tool-less solid centerpost with a unique Turnfastener technology



Tool-less and adjustable concealed hanging bracket system



Wall Cabinets are 330mm deep with 18mm void. Internal depth 304mm

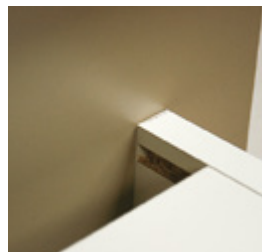

Base Cabinets are 570mm deep with 49mm void. Internal depth 513mm



Cover Caps 5mm colour matched and come as standard with every cabinet order



The mark of responsible forestry

ClicBox is FSC® Certified



Colours available

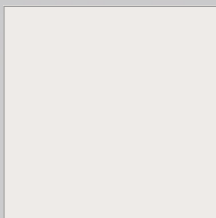

White

Kronospan: K101

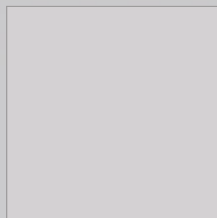

Grey

Kronospan: 0112

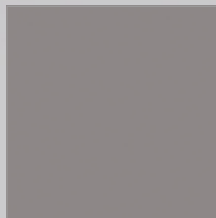

Dust Grey

Kronospan: 0171

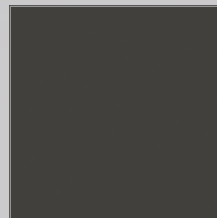

Anthracite

Kronospan: 0164

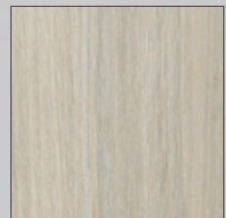

Urban Oak

Kronospan: K005

Cabinets

Base Cabinets

ClicBox cabinet range is pre-drilled to suit Hettich hinges and drawers

- All base Cabinets are 720mm H x 570mm D
- Includes tool-less adjustable legs 150mm H
- Hinge plate positions are centred 100mm top and bottom to suit a door drilling of 98mm top and bottom
- Hinge plate positions are pre drilled for euro screws



Highline Base

150 Wide

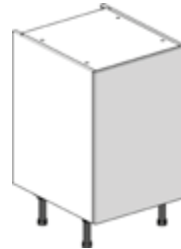

Highline Base

300/400/450/500/600 Wide



Highline Double Base

700/800/900/1000 Wide

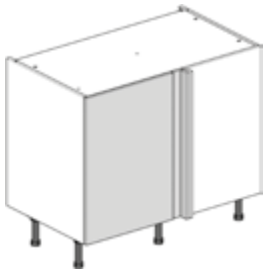

Blind Corner

700/800/900/1000 Wide

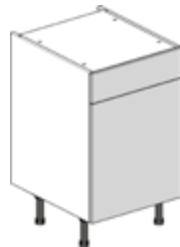

Drawerline Base

300/400/450/500/600 Wide



Drawerline Double Base

800/900/1000 Wide



5-Drawer Pack

(5 standard drawers)
300/500/600 Wide

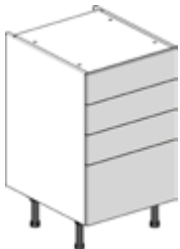

4-Drawer Pack

(3 standard + 1 pan drawer)
500/600 Wide

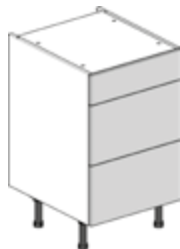

3-Drawer Pack

(1 standard + 2 pan drawers)
500/600/800/900/1000 Wide

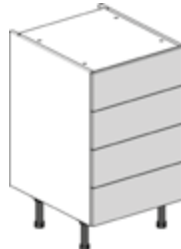

4-Drawer Pack

(4 standard drawers)
300/400/500/600 Wide

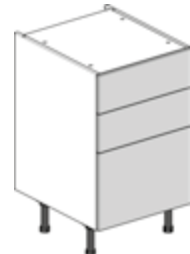

3-Drawer Pack

(2 standard + 1 pan drawer)
500/600 Wide

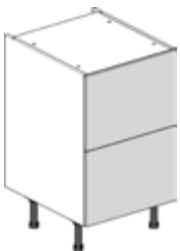

2-Drawer Pack

(2 pan drawers)
500/600/800/900/1000 Wide



Base Under Oven

600 Wide

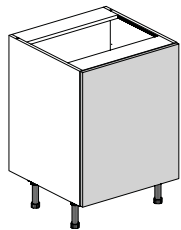

Sink Base

600 wide



Belfast Sink

600/800 Wide

Cabinets

Wall Cabinets

- Wall Cabinets are 575mm (short) 720mm (standard) & 900mm (tall) H x 330mm D
- Bridging Cabinets are 283mm (short) & 360mm (standard) H x 330mm D
- Includes tool-less adjustable hanging brackets
- Hinge plate positions are centred 100mm top and bottom to suit a door drilling of 98mm top and bottom
- Hinge plate positions are pre-drilled for euro screws

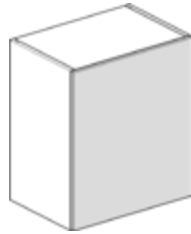

Wall (short)
300/400/450/500/600 Wide

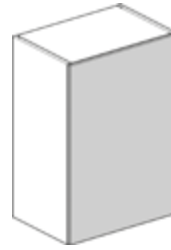

Wall
300/400/450/500/600 Wide

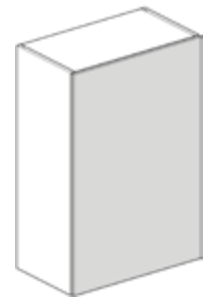

Wall (tall)
300/400/450/500/600 Wide

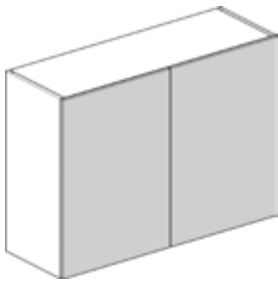

Double Wall
700/800/900/1000 Wide

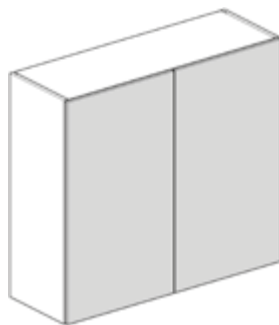

Double Wall (tall)
800/1000 Wide

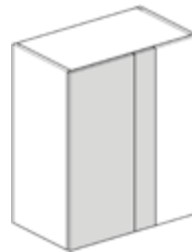

Blind Corner Wall
600 Wide

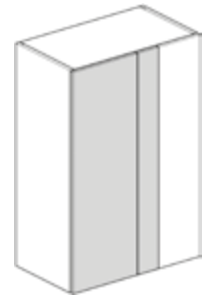

Blind Corner Wall (tall)
600 Wide

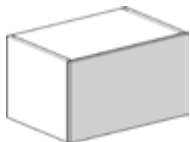

Bridging (short)
500/600 Wide

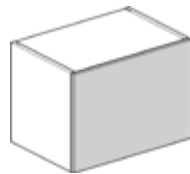

Bridging
500/600/800/900/1000 Wide

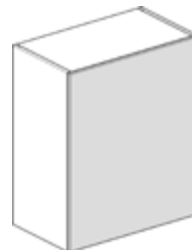

Boiler Cabinet
(Ready to Assemble)
600 Wide (450D, no back)

Cabinets

Tower Cabinets

- Tower Cabinets are 1970mm (standard) & 2150mm (tall) H x 570mm D
- Hinge plate positions are pre-drilled for euro screws
- Includes tool-less adjustable legs 150mm H
- Shelf packs included



Larder (standard)

300/400/500/600 Wide

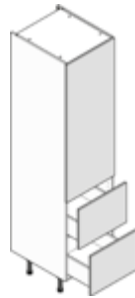

Larder with 2 Pan Drawers (standard)

500/600 Wide

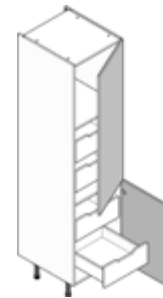

Larder with Inner Drawers (standard)

500/600 Wide



Larder with One Door (standard)

300/400/500/600 Wide



Larder (tall)

300/400/500/600 Wide

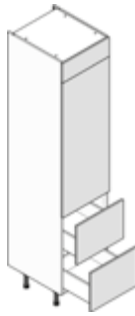

Larder with 2 Pan Drawers (tall)

500/600 Wide

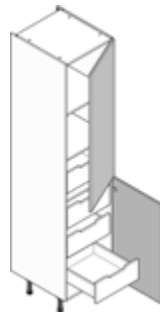

Larder with Inner Drawers (tall)

500/600 Wide



Larder with 1425 & 715 Doors (tall)

300/400/500/600 Wide



Larder with One Door (tall)

300/400/500/600 Wide

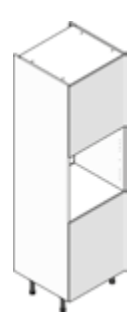

Single Oven (standard)

600 Wide

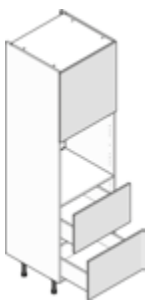

Single Oven with 2 Pan Drawers (standard)

600 Wide



Double Oven (standard)

600 Wide

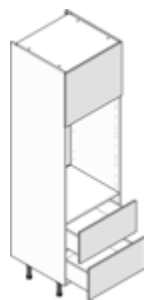

Double Oven with 2 Pan Drawers (standard)

600 Wide



Single Oven + Compact/Microwave (standard)

600 Wide

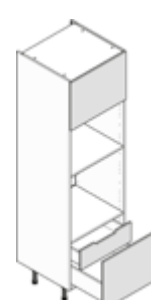

Single Oven + Compact/Microwave with 1 Pan Drawer + 1 Inner Drawer (standard)

600 Wide



Compact/Microwave (standard)

600 Wide

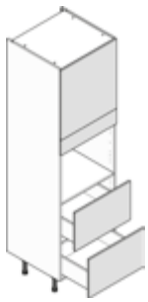

Compact/Microwave with 2 Pan Drawers (standard)

600 Wide



Single Oven (tall)

600 Wide

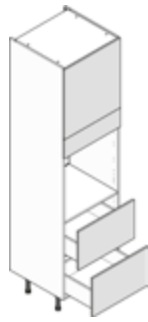

Single Oven with 2 Pan Drawers (tall)

600 Wide



Double Oven (tall)

600 Wide

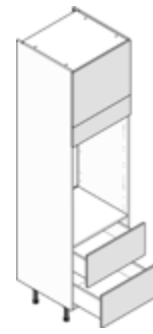

Double Oven with 2 Pan Drawers (tall)

600 Wide

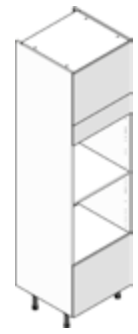

Single Oven + Compact / Microwave (tall)

600 Wide

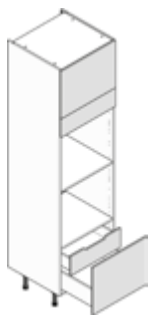

Single Oven + Compact / Microwave with 1 Pan Drawer + 1 Inner Drawer (tall)

600 Wide



Compact / Microwave (tall)

600 Wide

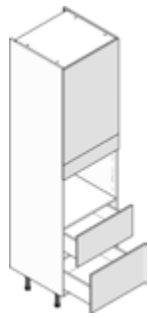

Compact/Microwave with 2 Pan Drawers (tall)

600 Wide

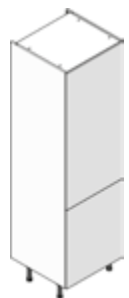

70/30 Cooling (standard)

600 Wide



50/50 Cooling (standard)

600 Wide

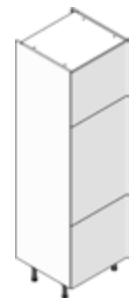

Single Cooling (standard)

600 Wide

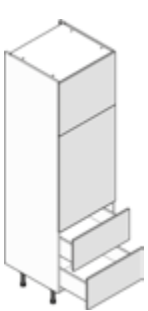

Single Cooling with 2 Pan Drawers (standard)

600 Wide



70/30 Cooling (tall)

600 Wide

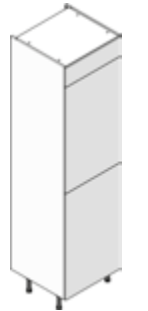

50/50 Cooling (tall)

600 Wide

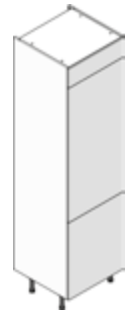

Single Cooling (tall)

600 Wide

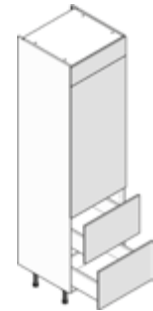

Single Cooling with 2 Pan Drawers (tall)

600 Wide

Cabinets

Blind Corner Units

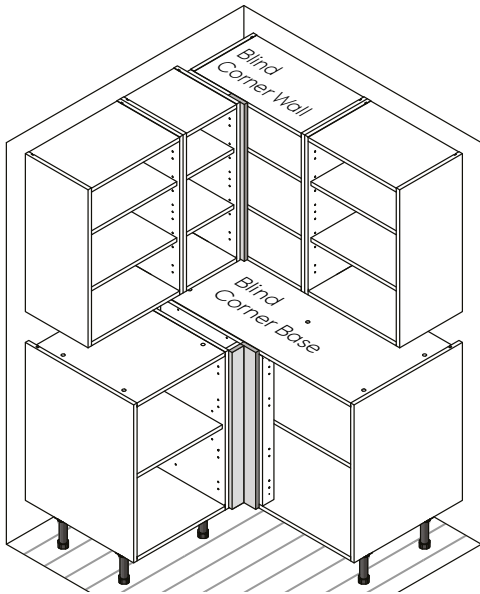

Blind Corner units are available in a variety of standard sizes, giving numerous options on planning out of a corner. Standard door and cabinet combinations are shown below – the system can be further tailored during installation, by trimming the corner post, and positioning of the cabinetry as shown opposite.

Standard Blind Corner Wall Unit (650 x 350)

This uses a standard 600 cabinet, together with a 300 door. Only one part of the corner post is required (80mm), together with blind corner hinges, which are used to hang the door off the rear face of the 80mm panel. The 61mm corner return is also supplied, should the unit need adjustment as shown opposite.

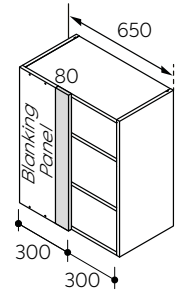

Always check any handle sizes for clearances that may be needed, and adjust the size of the corner post as necessary.

Two Part Corner Post

This is supplied in flat format to allow customisation on-site. In its maximum size, it measures 80 x 80mm when assembled. The 80mm piece is pre-drilled on the rear face for hinge mounting plates (Blind Corner Wall unit Door Hanging).

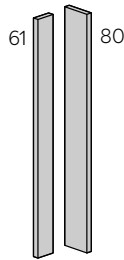

Standard Blind Corner Base Unit (1150 x 650)

This uses a standard 1000mm base cabinet, together with a 500mm door – other combinations are available, see below. Both parts of the corner post are required, and can be modified during installation as shown opposite.

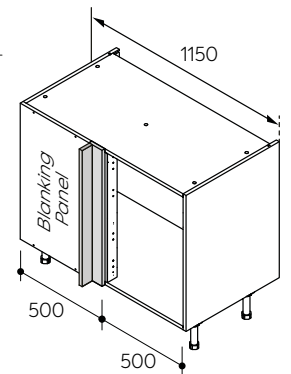

Standard Corner Base Options

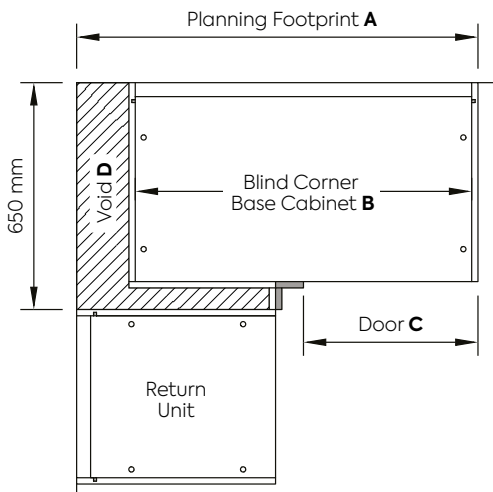

Blind corner base units are available in a variety of cabinet & door combinations as listed – they will all work with the 650 x 350 Blind Corner Wall unit above, together with the relevant size of return wall units.

Planning Footprint A	Cabinet B	Door C	Void D
1000	700	350	300
1050	800	400	250
1100	900	450	200
1150	1000	500	150
1100	1000	450	100
1050	1000	400	50
1250	1000	600	250

Cabinets

Blind Corner Units – Flexible Corner Planning

The nature of the two-part corner post is inherently flexible – it can be tailored during installation to achieve any corner configuration size required. This can be used when planning the overall kitchen design to remove the need for unsightly infill strips. Two typical specimen examples are shown below, however the corner planning options are limitless with a degree of thought, and careful planning.

Note: the 80mm panel does not need trimming in any scenario – the relevant base or wall cabinet is simply positioned further in (or out) of the corner, creating more (or less) reveal of the 80mm panel. The 61mm return piece is then trimmed and positioned accordingly.

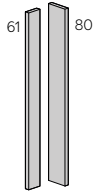

Example 1 – 1125mm Corner

- The blind corner wall cabinet is set at 675mm, with a 75mm void – making the corner post footprint 45 x 45 (26 x 26 visible)
- Standard 450mm wall units are used to align with the base units below
- The 1000mm blind corner base is set at 1125mm, with a 125mm void – making the corner post footprint 55 x 55 (36 x 36 visible).

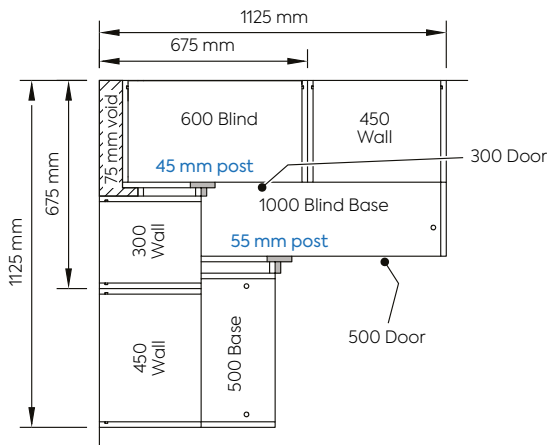

Example 2 – 1100mm Corner

- The blind corner wall is set at 700mm, with a 100mm void – making the corner post footprint 70 x 70 (51 x 51 visible).
- Standard 400mm wall units are used to align with the base units below.
- The 900mm blind corner base is set at 1100mm, with a 200mm void – making the corner post footprint 80 x 80 (does not need trimming) and a 450mm base return unit.

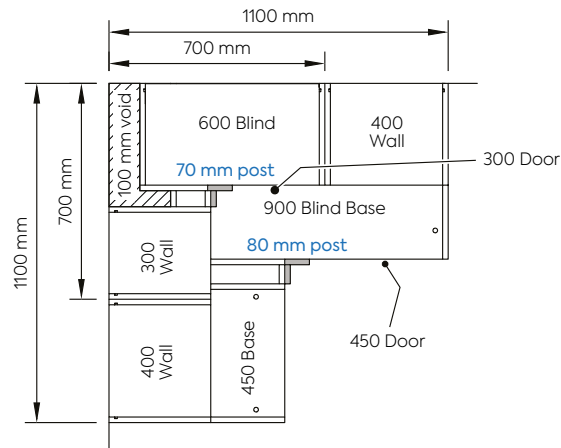

J-Pull Ranges: Jayline and Lacarre

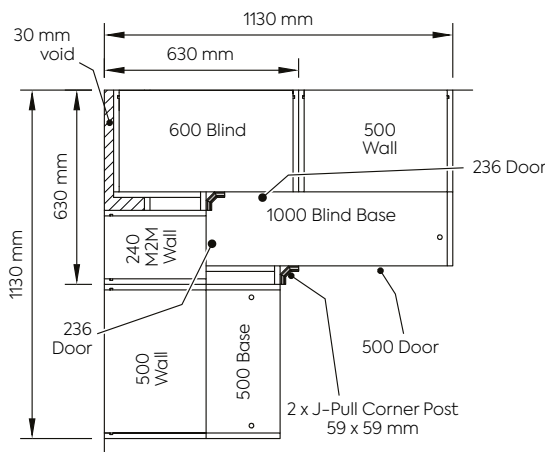

- For J-Pull ranges the corner post is a fixed size 59 x 59, with J-Pull design, used on both base and wall units to suit a 630 (Wall) and 1130 (Base) planning footprint.
- A 236mm corner wall door is used – note that this is hinged from the cabinet end panel using 165 degree hinges.
- A made-to-measure return wall unit (240mm wide) can be used together with a 236mm wide door, to align with the base units below, if required to match the overall kitchen plan.

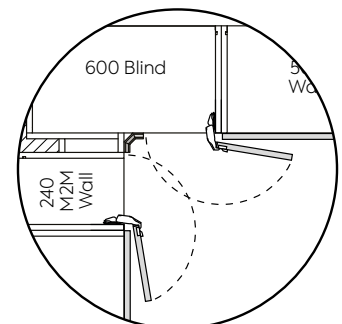
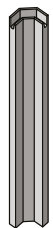

Tallstor™
Storage Solution



Tallstor™

Introducing Tallstor™, our unique stylish storage solution giving your customers even more choice.



Internal drawers match the frontal colour



Also available for base cabinet, shown here with 3 drawers.
Multiple drawer options available.



Internal drawers match the frontal colour.

Tallstor

Butler's Pantries

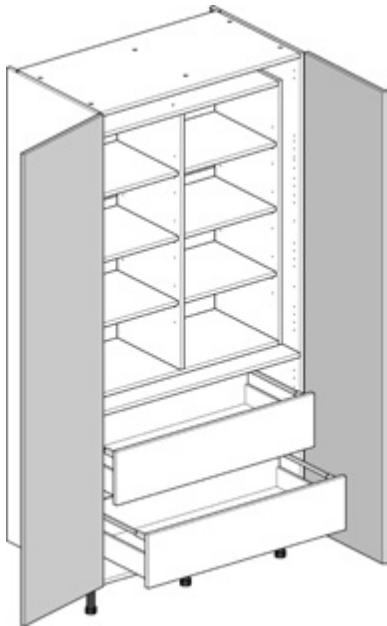

Butler's Pantry with
2x Internal Drawers (standard)

1000 Wide

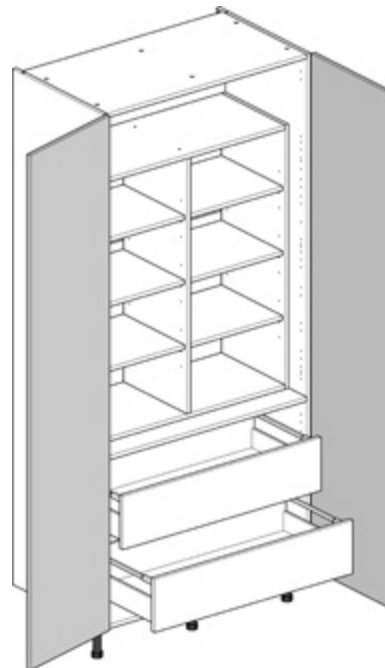

Butler's Pantry with
2x Internal Drawers (tall)

1000 Wide

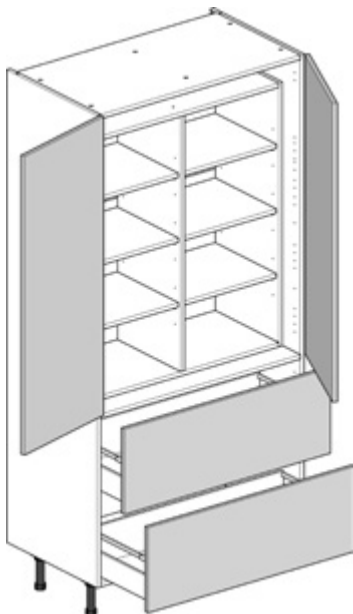

Butler's Pantry with
2x 355 Drawers (standard)

1000 Wide

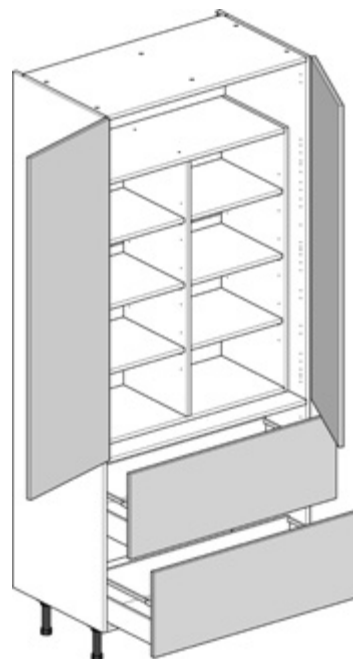

Butler's Pantry with
2x 355 Drawers (tall)

1000 Wide



A range of top quality Sensys & Interimat hinges from Hettich.

Tool-less snap on hinge to plate. Hinge plates are not supplied with hinges and must be ordered separately. Images show hinges with covers that are not supplied.



Blum Aventos HK-S Flap Door hinging system

With clip-on, fully adjustable door assembly and adjustable soft-closing mechanism that can be tailored to suit individual door weights. To suit doors up to 355mm high, and up to 900mm wide. Supplied with door fixing bracket, and light grey cover clips.
Code: HFLAPHINB



110° soft close Hinge (Sensys 8645i)

110° opening angle, soft close, 3 way adjustment, screw fix cup. For use on standard cabinets. Silver: H110SCHIN
Black: HB110SCHIN



165° Soft Close Hinge (Sensys 8657i)

165° opening angle, soft close, 3 way adjustment, screw fix cup. For use on corner cabinets. Silver: H165SCHIN
Black: HB165SCHIN



Interimat 110° Hinge for Integrated Fridge Freezer

For use with cross mounting plate for integrated fridge freezer (HCMPIFF) Silver: H110IFF



Cross Mounting Plate for Integrated Fridge Freezer

To be used with Interimat 110 hinge for Fridge Freezer Silver: HCMPIFF



Standard Hinge Mounting Plate (9071625)

Manual height adjustment +/- 3mm, 0.5mm rise, Euro screws. Suitable for Sensys & Interimat Hinges. Silver: HSHMPES
Black: HBSHMPES



Cam Adjustable Hinge Mounting Plate (9071665)

Cam height adjustment +/- 3mm, 0.5mm rise, Euro screws. Suitable for Sensys & Interimat Hinges. Silver: HAHMPES
Black: HBAHMPES

We stock all components necessary including Hettich machinery to produce top quality pre-assembled Atira soft close drawers so you don't have to...

Each drawer comes in 2 colours ready assembled and includes all components and screws required, shrink wrapped and individually boxed. **A Drawer in a Box...**

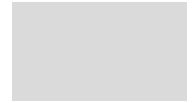

Silver



Graphite

Our Clicbox cabinets come in 5 colours and are predrilled to suit Hettich Atira drawers.

Drawer Specifications

Durable powder coated silver/graphite colour. Double wall steel sides & back with matching silver/graphite 16mm MFC base. Quadro silent soft close self cleaning runners with full 470 extension. 470mm deep drawer. 30kg load capacity. Tool-less height adjustment by thumb wheel (+/- 2mm). Easy lateral adjustment by screw driver (+/- 1.5mm).



Adjustable Drawer Divider Kits

Silver/Graphite divider kit to suit Atira High Sided Drawers. Kit includes 1 spring loaded divider plus cross dividers as follows: 600 W x 3, 800 W x 4, 900/1000 x 5. Codes below are for silver option. For graphite, add 'G' after 'H' e.g. HGADDK600

600mm W. Code: HADDK600
800mm W. Code: HADDK800
900mm W. Code: HADDK900
1000mm W. Code: HADDK1000



Cutlery/Organiser Trays to fit Atira Drawers

Graphite moulded trays with adjustable dividers.

500mm W. Code HGCT500SOT590
600mm W. Code HGCT600SOT590
800mm W. Code HGCT800SOT590
900mm W. Code HGCT900SOT590
1000mm W. Code HGCT1000SOT590



Atira Standard Drawers

Drawer height 70mm. Each drawer pack includes: Drawer, pair of runners, 2 x drawer front connectors, 2 x Hettich covers, screw pack (4 x euro screws & 4 x wood screws for runners, 4 x wood screws for drawer front connectors). Codes below are for silver option. For graphite, add 'G' after 'H' e.g. HGADS300SIN

300mm W. Code: HADS300SIN
400mm W. Code: HADS400SIN
450mm W. Code: HADS450SIN
500mm W. Code: HADS500SIN
600mm W. Code: HADS600SIN
800mm W. Code: HADS800SIN
900mm W. Code: HADS900SIN
1000mm W. Code: HADS1000SIN

Cross Rail Dividers

(pack of 15) Graphite drawer divider kit.
Code: HG15CRDDK (Graphite)



Atira High Sided Drawers

Drawer height 144mm. Each drawer pack includes: Drawer, pair of runners, 2 x side rails & connectors, 2 x drawer front connectors, 2 x Hettich covers, screw pack (4 x euro screws & 4 x wood screws for runners, 2 x screws for side rails, 4 x wood screws for drawer front connectors). Codes below are for silver option. For graphite, add 'G' after 'H' e.g. HGADP500SIN

300mm W. Code: HADP300SIN
400mm W. Code: HADP400SIN
450mm W. Code: HADP450SIN
500mm W. Code: HADP500SIN
600mm W. Code: HADP600SIN
800mm W. Code: HADP800SIN
900mm W. Code: HADP900SIN
1000mm W. Code: HADP1000SIN

- Stylish Design in Silver/ Graphite Finish
- Quadro Silence Soft Close
- 30kg Load Capacity (per drawer)
- Strong and Robust
- Full Drawer Extension
- Flexible Internal Accessories



Front Panel For Converting Standard Drawer to an Internal Storage Drawer

Order drawers separately. Drawer runners set back 32mm. Codes below are for silver option.

For graphite, add 'G' after 'H' e.g. HGIFP ASD400

400mm W. Code: HIFPASD400
 500mm W. Code: HIFPASD500
 600mm W. Code: HIFPASD600
 800mm W. Code: HIFPASD800
 900mm W. Code: HIFPASD900
 1000mm W. Code: HIFPASD1000



Front Panel For Converting High Sided Drawer to an Internal Storage Drawer

Order drawers separately. Drawer runners set back 32mm. Codes below are for silver option.

For graphite, add 'G' after 'H' e.g. HGIFPAHD500

500mm W. Code: HIFPAHD500
 600mm W. Code: HIFPAHD600



Glass Side Kit

Glass Side Kit to suit Atira High Sided Drawers. Kit contains 2 x Glass Sides with pre-mounted adapters + drawer front connectors.

Code: HGSK (Silver)
 Code: HGGSK (Graphite)

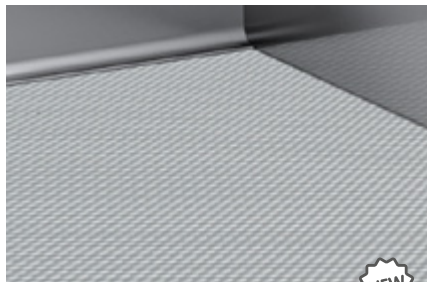

Anti Slip Matting

High quality Graphite matting for Atira drawer base. 470mm D.

400 Pre-Cut Drawer Mat Code: HCT400MAT
 450 Pre-Cut Drawer Mat Code: HCT450MAT
 500 Pre-Cut Drawer Mat Code: HCT500MAT
 600 Pre-Cut Drawer Mat Code: HCT600MAT
 800 Pre-Cut Drawer Mat Code: HCT800MAT
 900 Pre-Cut Drawer Mat Code: HCT900MAT
 1000 Pre-Cut Drawer Mat Code: HCT1000MAT



Tallstor Base Unit – see page 121.

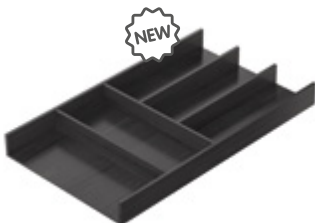

Cutlery Orgatray

270mm wide. Graphite
 Code: HCTORGCUTLERY



Roll Holder Orgatray

150mm wide. Graphite
 Code: HCTORGROLL



Knife Block Orgatray

150mm wide. Graphite
 Code: HCTORGKNIFE



Spice Racks Orgatray

150mm wide. Graphite
 Code: HCTORGSPICE

- Soft Closing Mechanism
- Full Extension runners
- Contemporary Graphite Finish
- Adjustable Door Fixing
- Fitting instructions supplied

150 Base Pull Out

Solid sides. Includes 2x anti slip mats & 4x bottle clips. Graphite. Code: **STORANT0051**



NEW



NEW

Nuvola Corner Storage System

Two widths to suit 450 and 500 doors (for 900 and 1000 cabinets). Left and right handed, two carousels per set, 25Kg loading. Solid Sides. Graphite. The upper carousel fixes to cabinet shelf. For door clearance we recommend using our slimline hinge – H110IFF.

450mm W. LH. Use with right hand blank corner. Code: **STORANT0055**

450mm W. RH. Use with left hand blank corner. Code: **STORANT0056**

500mm W. LH. Use with right hand blank corner. Code: **STORANT0057**

500mm W. RH. Use with left hand blank corner. Code: **STORANT0058**

500mm W. RH. Use with left hand blank corner. Code: **STORANT0058**



NEW

300 Base Pull Out

Solid sides. Includes 2x anti slip mats & 4x bottle holders. Graphite. Code: **STORANT0052**



NEW

300 Cooks Base Pull Out

Soft closing runners, steel frame, includes 4 clip-on plastic storage buckets with divider clips and knife slotted top. Centre slot for chopping board, wire bottom rails offer bottle support. 25kg loading. Code: **STORANT0059**



NEW

300 Pull Out Larder

500 deep. To suit a 300w tall cabinet. Five baskets, height adjustable. 120Kg loading. Solid Sides. Graphite. Code: **STORANT0053**



NEW

500 Pull & Swing Larder

470 deep. 1880 high. To suit a 500w tall cabinet. Five baskets, height adjustable. 80Kg loading. Solid Sides. Graphite. Code: **STORANT0054**





Undersink Bin 28L

28L two bin system, simple pull out action, ideal for compact spaces, 450mm deep, 255w x 390mm h.
Code: **STORANT0009**

- Soft closing mechanism
- Full extension runners
- Contemporary grey finish
- Integral bin lid
- Fitting instructions supplied
- Removable bin for ease of access and cleaning



Standard Pull Out Bin

400 Graphite: 2-Bin, 2x32L = 64L.
Code: **STORANT0061**
500 Graphite: 2-Bin, 2x35L = 70L.
Code: **STORANT0062**
600 Graphite: 3-Bin, 3x32L = 96L.
Code: **STORANT0063**



Premium Pull Out Bin

For use with Drawerline Base. Graphite.

400 Premium Pull Out Bin

2-Bin, 2x32L = 64L

Code: **STORANT0064**

500 Premium Pull Out Bin

2-Bin, 2x35L = 70L

Code: **STORANT0065**

600 Premium Pull Out Bin

3-Bin, 3x32L = 96L

Code: **STORANT0066**